

IRWIN®



PLIERS & WRENCHES

IRWIN®

WISE-GRIP®



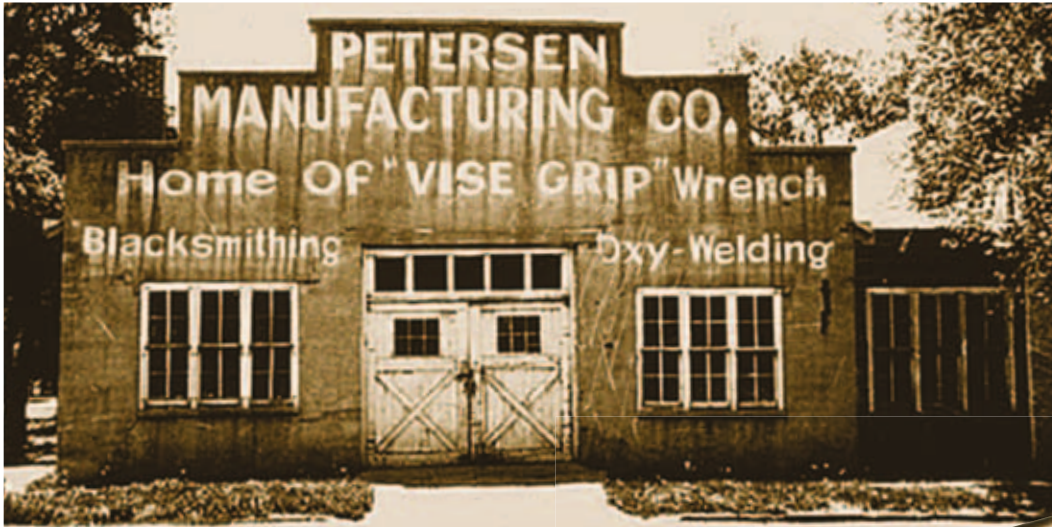

HISTORY

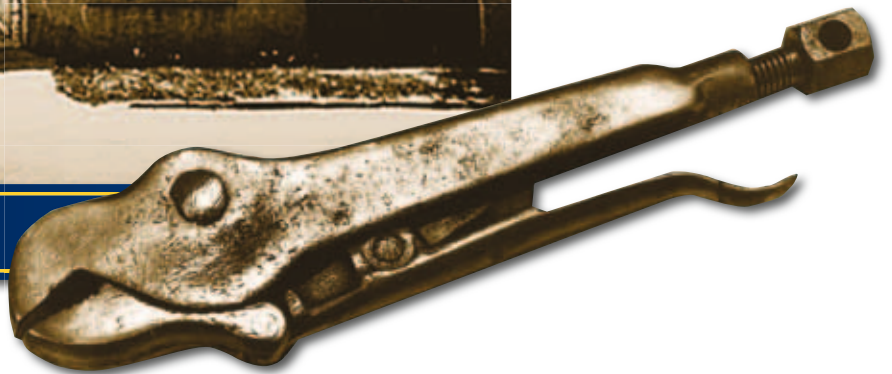

The choice of Professional Tradesmen since 1924

The VISE-GRIP® Locking Tool was invented in the 1924 by a blacksmith in a small town of DeWitt, Nebraska. William Petersen was a Danish immigrant who invented the first locking pliers in his blacksmith shop, and began selling them from the back of his car to farmers and people in surrounding towns. He patented his new idea and called it VISE-GRIP®.

Since then, VISE-GRIP® has gained global brand recognition as the first choice for Locking Pliers. Innovation and quality are the core values of the VISE-GRIP® brand. With proven performance in every turn, these are the tools that tradesmen choose first – and pass on to the next generation.

IRWIN® VISE-GRIP® family offers a full line of locking pliers, water pump & VDE Pliers. Certified by TÜV. IRWIN® VISE-GRIP® pliers and wrenches continue to set the standard for dependability, quality, and innovation... today and tomorrow. Wherever there's a need for a quality tool, IRWIN® VISE-GRIP® is on the job.

The Original Locking Plier



1948

Long Nose Plier



1996

Traditional Plier



2007

Groovelock



2012

1924



Locking C-Clamp

1978

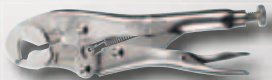

Locking Wrench

2005



VDE Plier

2011

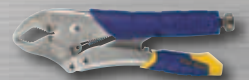

Fast Release

Fast Release

LOCKING PLIERS

The NEW IRWIN® Vise-Grip® Fast Release locking tools have a one handed, triggerless release, so they're twice as easy to open as the traditional design. Anti-pinch, non-slip ProTouch™ Grips provide comfort, control, and less hand fatigue.



1. UNIQUE CURVED JAW

Great for securely gripping and torquing multiple surface shapes, including round pipes, square or hex bolts, and more. Perfect for any application that requires maximum torque.

2. SELF-ENERGISING LOWER JAW

Jaw mechanism provides 3X more gripping power*
Pivot allows jaw to align on workpiece for maximum grip without slipping or stripping.

3. BUILT STRONG TO LAST LONG

2x Longer life† High grade alloy steel is heat treated for maximum toughness and durability.

4. PROTOUCH GRIPS

Provides comfort, control and less hand fatigue.

5. HEX KEY ADJUSTING SCREW

Tightens to draw material closer together for tighter grip.
Loosens to provide controlled release.

ProTouch™
GRIPS

2X

EASIER OPENING*



*vs. Traditional Locking Pliers

CURVED JAW LOCKING PLIERS

Self-energising lower jaw provides three times more gripping power, with no slipping or stripping on any style nut or bolt head.

Item No.	Description	Capacity	EAN	Master Pack	Shelf Pack
Fast Release™					
T10T	Fast Release™ - 5CR 5"/ 125mm	29mm	5706915081459	25	5
T13T	Fast Release™ - 7CR 7"/ 175mm	38mm	5706915081442	25	5
T11T	Fast Release™ - 10CR 10"/ 250mm	48mm	5706915081435	25	5
The Original™					
10508019	Original™ - 5CR 5"/ 125mm	29mm	5706915080193	25	5
10508018	Original™ - 7CR 7"/ 175mm	38mm	5706915080186	25	5
10508017	Original™ - 10CR 10"/ 250mm	48mm	5706915080179	25	5

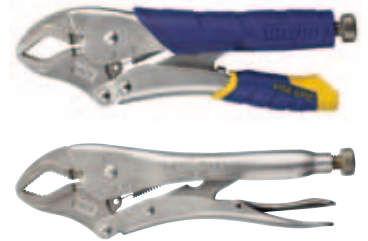

STRAIGHT JAW LOCKING PLIERS

Straight jaw provides maximum contact on flat, square or hex materials.

Item No.	Description	Capacity	EAN	Master Pack	Shelf Pack
Fast Release™					
T03T	Fast Release™ - 7R 7"/ 175mm	38mm	5706915081800	25	5
T01T	Fast Release™ - 10R 10"/ 250mm	48mm	5706915081794	25	5
The Original™					
T0302EL4	Original™ - 7R 7"/ 175mm	38mm	0038548003016	25	5
T0102EL4	Original™ - 10R 10"/ 250mm	48mm	0038548001067	25	5



CURVED JAW LOCKING PLIERS WITH WIRE CUTTER

Curved jaw with built-in wire cutter great for a variety of applications and material shapes.

Item No.	Description	Capacity	EAN	Master Pack	Shelf Pack
Fast Release™					
T09T	Fast Release™ - 5WR 5"/ 125mm	29mm	5706915081428	25	5
T07T	Fast Release™ - 7WR 7"/ 175mm	38mm	5706915081411	25	5
T05T	Fast Release™ - 10WR 10"/ 250mm	48mm	5706915081404	25	5
The Original™					
T1002EL4	Original™ - 4WR 4"/ 100mm	25mm	0038548001098	25	5
T0902EL4	Original™ - 5WR 5"/ 125mm	29mm	0038548009063	25	5
T0702EL4	Original™ - 7WR 7"/ 175mm	38mm	0038548007038	25	5
T0502EL4	Original™ - 10WR 10"/ 250mm	48mm	0038548000510	25	5

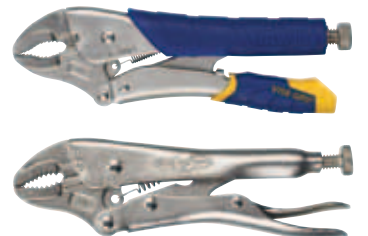

LONG NOSE LOCKING PLIERS WITH WIRE CUTTER

Long, straight nose provides easy access in narrow, hard-to-reach places.

Item No.	Description	Capacity	EAN	Master Pack	Shelf Pack
Fast Release™					
T14T	Fast Release™ - 6LN 6"/150mm	51mm	5706915081466	25	5
T15T	Fast Release™ - 9LN 9"/225mm	70mm	5706915081473	25	5
The Original™					
T1602EL4	Original™ - 4LN 4"/100mm	41mm	0038548001678	25	5
T1402EL4	Original™ - 6LN 6"/150mm	51mm	0038548001432	25	5
T1502EL4	Original™ - 9LN 9"/225mm	70mm	0038548001517	25	5



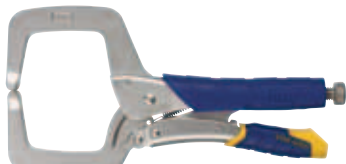

LOCKING C-CLAMPS WITH REGULAR TIPS

Wide-opening jaw provides greater versatility in clamping a variety of shapes.

Item No.	Description	Capacity	EAN	Master Pack	Shelf Pack
Fast Release™					
10507190	Fast Release™ - 6R 6"/150mm	54mm	5706915071900	25	5
10507189	Fast Release™ - 11R 4"/275mm	102mm	5706915071894	25	5
The Original™					
T17EL4	Original™ - 6R 6"/150mm	54mm	0038548001715	25	5
T19EL4	Original™ - 11R 11"/275mm	102mm	0038548001913	25	5
T18R	Original™ - 18R - 18"/455mm	203mm	0038548000213	-	5
T24R	Original™ - 24R - 24"/605mm	254mm	0038548002750	-	5

LOCKING C-CLAMPS - DEEP THROAT

The large C-Clamp with greater throat capacity makes this a highly versatility tool in the clamping of wider work-pieces.

Item No.	Description	Capacity	EAN	Master Pack	Shelf Pack
T9DR	Original™ - 9DR Locking Clamp Deep Throat 9"/225mm	114mm	0038548003009	-	5
T18DR	Original™ - 18DR Locking Clamp Deep Throat 18"/455mm	190mm	0038548002118	-	5

LOCKING C-CLAMPS WITH SWIVEL PADS

The swiveling pads and greater throat depth allow this clamp to be hold irregular shapes and tapered work pieces.

Item No.	Description	Capacity	EAN	Master Pack	Shelf Pack
T165EL4	Original™ - 4SP Locking C-Clamp 4"/100mm	41mm	0038548001661	25	5
T18EL4	Original™ - 6SP Locking C-Clamp 6"/150mm	54mm	0038548001845	25	5
T9SP	Original™ - 9SP Locking C-Clamp 9"/225mm	114mm	0038548003108	25	5
T20EL4	Original™ - 11SP Locking C-Clamp 11"/275mm	102mm	0038548002019	25	5
T18SP	Original™ - 18SP Locking C-Clamp 18"/455mm	203mm	0038548000220	-	5
T24SP	Original™ - 24SP Locking C-Clamp 24"/605mm	254mm	0038548000282	-	5

LOCKING WRENCHES

The jaws lock onto 3 sides of a hex fastener preventing the jaws from slipping, preventing rounding or marring of the fastener.

Item No.	Description	Capacity	EAN	Master Pack	Shelf Pack
T4LW	Original™ - 4LW Locking Wrench 4"/100mm	7-14mm	0038548002422	25	5
T7LW	Original™ - 7LW Locking Wrench 7"/175mm	11-19mm	0038548002415	25	5
T10LW	Original™ - 10LW Locking Wrench 10"/250mm	16-28mm	0038548000022	25	5

LARGE JAW LOCKING PLIERS

The large jaw clamps expand your use of locking pliers to many new applications. Excellent for plumbing & automotive applications.

Item No.	Description	Capacity	EAN	Master Pack	Shelf Pack
T12EL4	Original™ - 12LC Large Jaw Locking Plier 12"/300mm	79mm	0038548001210	25	5

LOCKING SHEET METAL TOOL

In the forming and shaping of sheet material, the sheet metal tool allows for the safe handling of the metal.

Item No.	Description	Capacity	EAN	Master Pack	Shelf Pack
T23EL4	Original™ - 8R Locking Sheet Metal Tool 8"/200mm	78mm	0038548002323	25	5

LOCKING PINCH-OFF TOOL

The pinch-off tool provides a temporary seal when applied to tubing, leaving both hands free for other work.

Item No.	Description	Capacity	EAN	Master Pack	Shelf Pack
T29EL4	Original™ - RR Locking Pinch-Off Tool 7"/175mm	6mm	0038548002903	25	5

LOCKING PANEL CLAMP

Provides quick clamping and alignment of auto body panels

Item No.	Description	Capacity	EAN	Master Pack	Shelf Pack
T251EL4	Original™ - 9AC Locking Panel Clamp 9"/225mm	70mm	0038548002514	25	5



Locking Clamps & Plier Sets

LOCKING WELDING CLAMP

Allows accurate alignment of both round & squares shapes tubing during welding. U-shape jaws allow visibility of the weld area.

Item No.	Description	Capacity	EAN	Master Pack	Shelf Pack
T25EL4	Original™ - 9R Locking Welding Clamp 9"/225mm	70 mm	0038548002545	25	5



LOCKING CHAIN CLAMP

Holds and locks any shape or size up to 18"/455mm. Extension chains are available to extend to any length required.

Item No.	Description	EAN	Master Pack	Shelf Pack
T27EL4	Original™ - 20R Locking Chain Clamp 9"/225mm	0038548002705	10	5
T40EXT	Original™ - 20EXT Extension chain 18"/455mm, fits 20R	0038548000404	1	1
T40REP	Original™ - 20REP Replacement chain 18"/455mm, fits 20R	0038548001401	1	1



LOCKING PLIERS SPARE PARTS

Item No.	Description	EAN	Pce per Pack	Master Pack	Shelf Pack
2071910	Adjustment Screw 10" - 24" Tools	0038548095455	5	100	5
4092	Replacement Spring 18" - 24" Tools	0038548040929	5	100	5
4935309	Replacement Spring 10" - 12" Tools	0038548040349	5	100	5
4008	Replacement Spring 7" - 9" Tools	0038548040080	5	100	5
4022ZR	Replacement Spring 5" - 6" Tools	0038548040226	5	100	5
4052ZR	Replacement Spring 4" Tools	0038548040523	5	100	5



LOCKING PLIERS SETS



T214T



T76KBT



T76KBT



10508020













T71





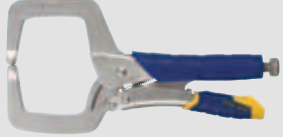





T00211

Item No.	Description	EAN	Master Pack	Shelf Pack
T77T	2 pc. Fast Release™ - (10WR, 6LN)	5706915081480	25	5
T214T	2 pc. Fast Release™ - (10WR, 7WR)	5706915081497	25	5
T76KBT	3 pc. Fast Release™ - (10WR, 9LN, 7R) in kitbag	5706915081503	25	5
10508020	3 pc. Original™ - (5CR, 7CR, 10CR) in storage tray	5706915080209	25	5
T71	4 pc. Original™ - (10CR, 7R, 6LN, 5WR), in kitbag	0038548000718	-	5
T00211	Empty Locking Pliers Display Board to fit one of: 10R, 7R, 10WR, 7WR, 5WR, 4WR, 10CR, 7CR, 9LN, 6LN, 4LN	0038548300023	1	1

Image	Item No.	Description	Sizes	Jaw Capacity	Description	Recommended Applications
	T10T	5CR 5"/ 125mm	5" / 125mm	1-1/8" (29 mm)	CURVED JAW LOCKING PLIERS Great for securely gripping and torquing multiple surface shapes, including round pipes, square or hex bolts, and more. Perfect for any application that requires maximum torque.	Gripping Torque Rusted/Broken Screws
	T13T	7CR 7"/ 175mm	7" / 175mm	1-1/2" (38 mm)		
	T11T	10CR 10"/ 250mm	10" / 250mm	1-7/8" (48 mm)		
	10508019	5CR 5"/ 125mm	5" / 125mm	1-1/8" (29 mm)		
	10508018	7CR 7"/ 175mm	7" / 175mm	1-1/2" (38 mm)		
	10508017	10CR 10"/ 250mm	10" / 250mm	1-7/8" (48 mm)		
	T03T	7R 7"/ 175mm	7" / 175mm	1-1/2" (38 mm)	STRAIGHT JAW LOCKING PLIERS The straight jaw pliers with heavy-duty jaws allow for maximum contact on all work shapes flat or square. It is very popular in welding and other metal work. Use for safer grinding or as a portable vice.	Holding Welding Clamping
	T01T	10R 10"/ 250mm	10" / 250mm	1-7/8" (48 mm)		
	T0302EL4	7R 7"/ 175mm	7" / 175mm	1-1/2" (38 mm)	The solid steel head makes this tool twice as strong as all other locking pliers.	
	T0102EL4	10R 10"/ 250mm	10" / 250mm	1-7/8" (48 mm)		
	T09T	5WR 5"/ 125mm	5" / 125mm	1-1/8" (29 mm)	CURVED JAW LOCKING PLIERS WITH WIRE CUTTER The curved jaw pliers provide for a better fit around curved work shapes. Curved jaw with built-in wire cutter great for a variety of applications and material shapes.	Wire Cutting Pulling, Prying Gripping
	T07T	7WR 7"/ 175mm	7" / 175mm	1-1/2" (38 mm)		
	T05T	10WR 10"/ 250mm	10" / 250mm	1-7/8" (48 mm)		
	T1002EL4	4WR 4"/ 100mm	4" / 100mm	1" (25 mm)		
	T0902EL4	5WR 5"/ 125mm	5" / 125mm	1-1/8" (29 mm)		
	T0702EL4	7WR 7"/ 175mm	7" / 175mm	1-1/2" (38 mm)		
	T0502EL4	10WR 10"/ 250mm	10" / 250mm	1-7/8" (48 mm)		
	T14T	6LN 6"/150mm	6" / 150mm	2" (51 mm)	LONG NOSE LOCKING PLIERS WITH WIRE CUTTER The long tapered nose plier is ideal for delicate work, hobbies, tight spaces, electronics and clamping of small parts. The long nose plier features a built in wire cutter which is helpful in tight spaces.	Reaching Bending Pinching
	T15T	9LN 9"/225mm	9" / 225mm	2-3/4" (70 mm)		
	T1602EL4	4LN 4"/100mm	4" / 100mm	1-5/8" (41 mm)		
	T1402EL4	6LN 6"/150mm	6" / 150mm	2" (51 mm)		
	T1502EL4	9LN 9"/225mm	9" / 225mm	2-3/4" (70 mm)		
	10507190	6R 6"/ 150mm	6" / 150mm	2-1/8" (54 mm)	LOCKING C-CLAMPS WITH REGULAR TIPS The wide-opening jaws provide the user greater versatility in clamping projects than otherwise available with old fashioned clamps. The C-clamps with regular tips is very popular in welding, auto-body repair and other metal work. The fast release option allows users to move the clamps quickly with one hand while continuing to work with the other.	Fabricating Welding Construction
	10507189	11R 11"/ 275mm	11" / 275mm	4" (102 mm)		
	T17EL4	6R 6"/ 150mm	6" / 150mm	2-1/8" (54 mm)		
	T19EL4	11R 11"/ 275mm	11" / 275mm	4" (102 mm)		
	T18R	18R 18"/ 455mm	18" / 455mm	8" (203 mm)		
	T24R	24R 24"/ 605mm	24" / 254mm	10" (254 mm)		

Locking Plier Range Overview

Image	Item No.	Description	Sizes	Jaw Capacity	Description	Recommended Applications
	T165EL4 T18EL4 T9SP T20EL4 T18SP T24SP	4SP 4"/ 100mm 6SP 6"/ 150mm 9SP 9"/ 225mm 11SP 11"/ 275mm 18SP 18"/ 455mm 24SP 24"/ 605mm	4"/ 100mm 6"/ 150mm 9"/ 225mm 11"/ 275mm 18"/ 455mm 24"/ 254mm	1-5/8" (41 mm) 2-1/8" (54 mm) 4-1/2" (114 mm) 4" (102 mm) 8" (203 mm) 10" (254 mm)	LOCKING C-CLAMPS WITH SWIVEL PADS The wide-opening jaws with swivel pads hold tapered work, awkward fabricating jobs and delicate projects. The C-Clamps with swivel pads are very popular in auto-body repair and other work on delicate or odd shaped surfaces.	Holding Delicate Seams
	T9DR T18DR	9DR 9"/ 225mm 18DR 18"/ 455mm	9"/ 225mm 18"/ 455mm	4-1/2" (114 mm) 7-1/2" (190 mm)	LOCKING C-CLAMPS - DEEP THROAT These clamps have extra throat width and depth for greater clamping reach. These features allow for many clamping applications in welding, automotive and steel framing.	Fabricating Welding Construction
	T23EL4	8R 8"/ 200mm	8"/ 200mm	3-1/8" (78 mm)	LOCKING SHEET METAL TOOL The Locking Sheet Metal tool locks to work with powerful grip. Makes all kinds of bending, forming, crimping jobs easier and faster.	Bending Crimping Forming
	T25EL4	9R 8"/ 225mm	9"/ 225mm	2-3/4" (70 mm)	LOCKING WELDING CLAMP The Locking Welding Clamp has deep-throated and U-shaped jaws for visibility and working space. Holds work in proper alignment. Use on sheet metal work on automobiles.	Welding Holding
	T27EL4	20R 9"/ 225mm	9"/ 225mm	18" (455 mm)	LOCKING CHAIN CLAMP The Locking Chain Clamp holds and locks around any shape or any size of object and adjusts quickly for ratchet action in either direction. Extension chain is available.	Holding
	T29EL4	RR 7"/ 175mm	7"/ 175mm	1/4" (6 mm)	LOCKING PINCH-OFF TOOL The Locking Pinch-Off tool with round jaws pinches and locks on tubing instantly without damaging the tubing. Perfect to use for plumbing work, stops flow from untidy tubes. Very popular in the refrigeration market.	Holding
	T251EL4	9AC Locking Panel Clamp	9"/ 225mm	2-3/4" (70 mm)	LOCKING PANEL CLAMP The jaws for the Locking Panel Clamp are designed to move in a straight line motion which allows the handle to be out of the way. Auto-body panels can be clamped in place and the door shut to check for gaps before final welding.	Clamping Welding
	T4LW T7LW T10LW	4LW 4"/ 100mm 7LW 7"/ 175mm 10LW 10"/ 250mm	4"/ 100mm 7"/ 175mm 10"/ 250mm	(7 mm - 14 mm) (11 mm - 19 mm) (16 mm - 28 mm)	LOCKING WRENCH The jaws of the Locking Wrench lock on three sides of a bolt and will not slip or mark. The Locking Wrench is adjustable to over 16 wrench sizes and features a built-in wire cutter.	Pulling Tightening
	T12EL4	12LC 12"/ 300mm	12"/ 300mm	3-1/8" (79 mm)	LARGE JAW LOCKING PLIER The large jaws and clamping ability make this tool ideal for plumbers, mechanics, welders and others who work with large objects. Also, its convenient size makes it easier to use than bulkier tools, such as pipe wrenches.	Holding Clamping

IRWIN®

WISE-GRIP®



GROOVELOCK WATER PUMP PLIERS WITH PROTOUCH GRIP

GrooveLock Pliers are designed with twice the number of groove positions of traditional groove joint pliers to deliver optimal hand and jaw positioning - providing a superior grip. The specially engineered, all-purpose jaw grips round, hex, square and flat surfaces for incredible versatility.

GrooveLock
Pliers

IRWIN® VISE-GRIP® GV10
GROOVELOCK



2X FASTER*
*vs traditional groove joint pliers



1. ALL-PURPOSE JAW:

Grips onto flat, round, hex & square work pieces to provide tremendous bite

2. PRESS-N-SLIDE BUTTON:

Adjusts jaws 2X faster than traditional groove joint pliers

3. MULTI-GROOVE RATCHETING SYSTEM:

Has twice the groove positions than other groove joint pliers, for precise positioning on any type of work surface

4. ANTI-PINCH NON-SLIP PROTOUCH™ GRIPS:

Provide comfort, control and less hand fatigue

ProTouch
GRIPS

GROOVELOCK WATER PUMP PLIERS WITH PROTOUCH GRIP

Item No.	Description	Jaw Capacity	EAN	Master Pack	Shelf Pack
10507626	GV6 GrooveLock PTG 6"/150mm	29mm	5706915076264	25	5
10507627	GV8 GrooveLock PTG 8"/200mm	45mm	5706915076271	25	5
10507628	GV10 GrooveLock PTG 10"/250mm	57mm	5706915076288	25	5
10507820	GV10S GrooveLock PTG 10"/250mm Smooth Jaw	57mm	5706915078206	25	5
10507629	GV12 GrooveLock PTG 12"/300mm	70mm	5706915076295	25	5



GROOVELOCK WATER PUMP PLIERS WITH THIN GRIP

Item No.	Description	Jaw Capacity	EAN	Master Pack	Shelf Pack
10507630	GV6 GrooveLock TG 6"/150mm	29mm	5706915076301	25	5
10507631	GV8 GrooveLock TG 8"/200mm	45mm	5706915076318	25	5
10507632	GV10 GrooveLock TG 10"/250mm	57mm	5706915076325	25	5
10507633	GV12 GrooveLock TG 12"/300mm	70mm	5706915076332	25	5
10507194	GV16 GrooveLock TG 16"/400mm	114mm	5706915071948	10	2
10507195	GV20 GrooveLock TG 20"/510mm	152mm	5706915071955	5	1



GROOVELOCK WATER PUMP PLIERS WITH PROTOUCH GRIP SETS

Item No.	Description	Jaw Capacity	EAN	Master Pack	Shelf Pack
184066	GrooveLock 2pc Set (GV8, GV10)	45mm, 57mm	5706918404668	-	5



UNIVERSAL WATER PUMP PLIERS WITH PROTOUCH GRIP



Item No.	Description	Jaw Capacity	EAN	Master Pack	Shelf Pack
10507634	Universal Water Pump Pliers PTG 6"/150mm	29mm	5706915076349	25	5
10507635	Universal Water Pump Pliers PTG 8"/200mm	45mm	5706915076356	25	5
10507636	Universal Water Pump Pliers PTG 10"/250mm	57mm	5706915076363	25	5
10507637	Universal Water Pump Pliers PTG 12"/300mm	70mm	5706915076370	25	5

UNIVERSAL WATER PUMP PLIERS WITH THIN GRIP



Item No.	Description	Jaw Capacity	EAN	Master Pack	Shelf Pack
10507638	Universal Water Pump Pliers TG 6"/150mm	29mm	5706915076387	25	5
10507639	Universal Water Pump Pliers TG 8"/200mm	45mm	5706915076394	25	5
10507640	Universal Water Pump Pliers TG 10"/250mm	57mm	5706915076400	25	5
10507641	Universal Water Pump Pliers TG 12"/300mm	70mm	5706915076417	25	5

GROOVE JOINT PLIERS

IRWIN® VISE-GRIP® Groove Joint pliers feature right angle teeth which grip in all directions for maximum bite. They all have moulded ProTouch grips for added comfort and less hand fatigue. TÜV/GS approvals demonstrate the high manufacturing standards of the VISE-GRIP® sub-brand.



Item No.	Description	Jaw Capacity	EAN	Master Pack	Shelf Pack
10505498	Groove Joint Plier 8"/200mm	38mm	5706915054989	25	5
10505500	Groove Joint Plier 10"/250mm	51mm	5706915055009	25	5
10505502	Groove Joint Plier 12"/300mm	57mm	5706915055023	25	5



WISE-GRIP PLIERS

IRWIN® WISE-GRIP® pliers have induction hardened cutting edges which stay sharp longer. The pliers also feature machined jaws for maximum gripping strength and moulded ProTouch grips for added comfort and less hand fatigue. TÜV/GS approvals demonstrate the high manufacturing standards of the WISE-GRIP® sub-brand.



IRWIN® WISE-GRIP® COMBINATION PLIER

- 1. MULTI GRIP JAWS** 
Groove direction
- 2. INDUCTION HARDENED CUTTING FACE**
To stay sharper longer
- 3. CABLE CUTTER**
Up to Ø 1,6 mm cables
- 4. CHROMIUM NICKEL STEEL**
For improved durability on the gripping and cutting face
- 5. PROTOUCH™ GRIPS:**
Are moulded for comfort and provide less hand fatigue

All Products on these pages are TÜV/GS certified for optimal safety and user confidence.



COMBINATION PLIERS

Item No.	Description	EAN	Master Pack	Shelf Pack
10505875	Combination Plier 6"/150mm	5706915058758	25	5
10505877	Combination Plier 7"/175mm	5706915058772	25	5
10505876	Combination Plier 8"/200mm	5706915058765	25	5



DIAGONAL PLIERS

Item No.	Description	EAN	Master Pack	Shelf Pack
10505493	Diagonal Cutting Pliers 6"/150mm	5706915054934	25	5
10505494	Diagonal Cutting Pliers 7"/175mm	5706915054941	25	5
10505495	Diagonal Cutting Pliers 8"/200mm	5706915054958	25	5

END CUTTING PLIERS

Item No.	Description	EAN	Master Pack	Shelf Pack
10505517	End Cutting Pliers 8"/200mm	5706915055177	25	5
10505518	Cable Cutter 8"/200mm	5706915055184	25	5

LONG NOSE PLIERS

Item No.	Description	EAN	Master Pack	Shelf Pack
10505503	Long Nose Pliers 6"/150mm	5706915055030	25	5
10505504	Long Nose Pliers 8"/200mm	5706915055047	25	5

BENT NOSE PLIERS

Item No.	Description	EAN	Master Pack	Shelf Pack
10505505	Bent Nose Pliers 6"/150mm	5706915055054	25	5
10505506	Bent Nose Pliers 8"/200mm	5706915055061	25	5

NIPPER PLIERS

Item No.	Description	EAN	Master Pack	Shelf Pack
10508153	Nipper Plier TG 6"/150mm	5706915081510	25	5
10508152	Nipper Plier TG 7"/175mm	5706915081527	25	5
10508151	Nipper Plier TG 8"/200mm	5706915081534	25	5

CONSTRUCTION NIPPERS

Item No.	Description	EAN	Master Pack	Shelf Pack
10508154	Construction Nippers TG 9"/225mm	5706915081541	25	5
10508155	Construction Nippers 9"/225mm, No Grip	5706915081558	25	5

NAIL PULLERS

Item No.	Description	EAN	Master Pack	Shelf Pack
10508156	Nail Puller TG 10"/250mm	5706915081565	25	5
10508157	Nail Puller TG 8"/200mm	5706915081572	25	5

ADJUSTABLE WRENCHES

Item No.	Description	Capacity	EAN	Master Pack	Shelf Pack
10505486	Adjustable Wrench PTG 6"/150mm	1"/25mm	5706915054866	25	5
10505488	Adjustable Wrench PTG 8"/200mm	1-1/8" / 28mm	5706915054880	25	5
10505490	Adjustable Wrench PTG 10"/250mm	1-1/4" / 31mm	5706915054903	25	5
10505492	Adjustable Wrench PTG 12"/300mm	1-1/2" / 38mm	5706915054927	20	5
10508161	Adjustable Wrench Steel Handle 6"/150mm	1" / 25mm	5706915081619	20	5
10508160	Adjustable Wrench Steel Handle 8"/200mm	1-1/8" / 28mm	5706915081602	20	5
10508159	Adjustable Wrench Steel Handle 10"/250mm	1-1/4" / 31mm	5706915081596	20	5
10508158	Adjustable Wrench Steel Handle 12"/300mm	1-1/2" / 38mm	5706915081589	20	5

TRADITIONAL PLIER SETS

Item No.	Description	EAN	Master Pack	Shelf Pack
10505483	ProPliers 3pcs Set (6"/150mm diagonal cutter, 8"/200mm long nose plier, 7"/175mm combination plier)	5706915054835	5	5



VDE PLIERS

IRWIN® Vise-Grip® VDE Pliers are fully TÜV, GS and VDE certified, meaning they are guaranteed safe for working with live electrical equipment up to AC 1000V or DC 1500V. Induction hardened cutting edge stay sharp longer. Machined jaws for maximum gripping strength. ProTouch™ grips provide extra comfort for less hand fatigue.

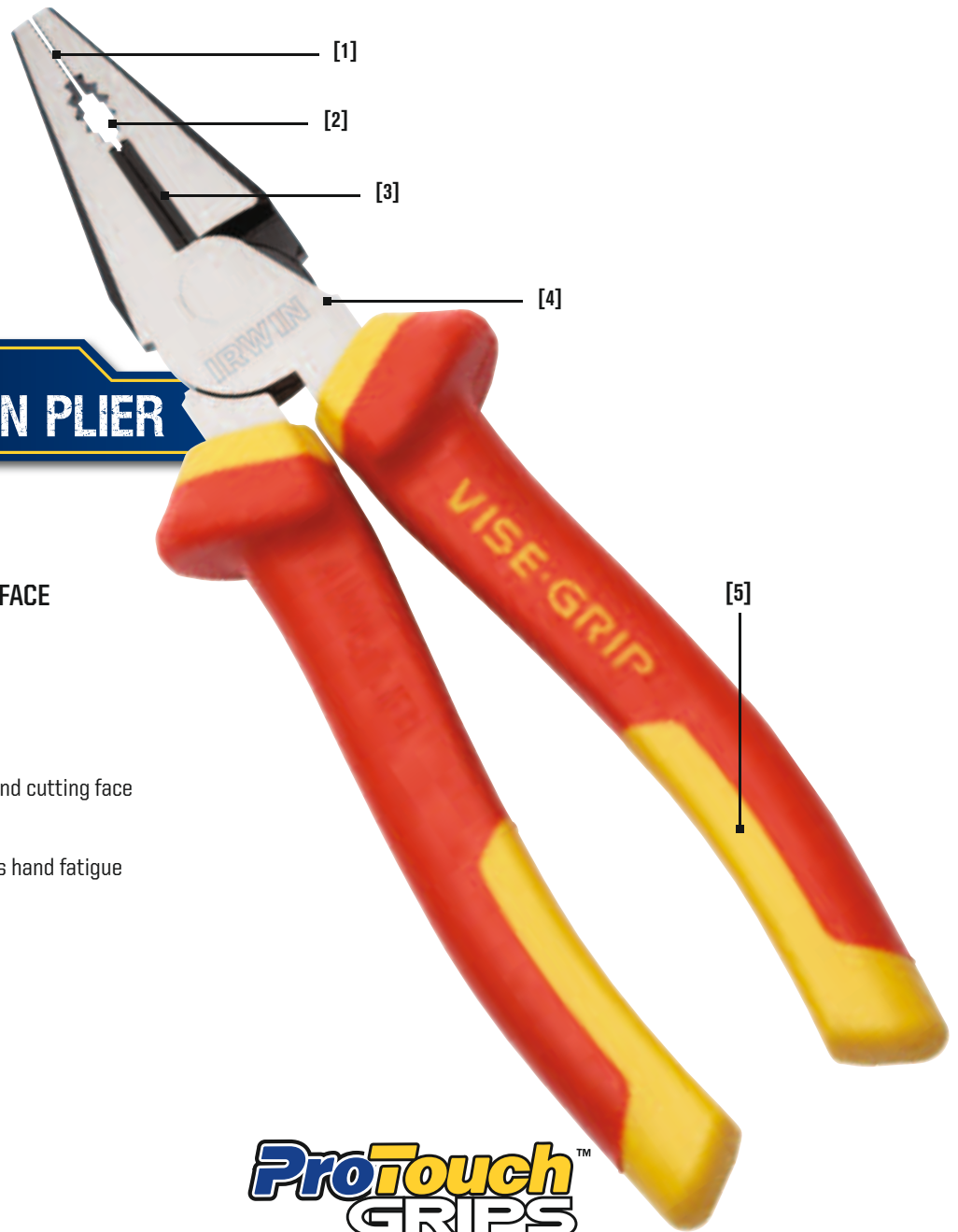

IRWIN® VISE-GRIP® VDE COMBINATION PLIER

- 1. MULTI GRIP JAWS** 
Groove direction
- 2. INDUCTION HARDENED CUTTING FACE**
To stay sharper longer
- 3. CABLE CUTTER**
Up to Ø 1,6 mm cables
- 4. CHROMIUM NICKEL STEEL**
For improved durability on the gripping and cutting face
- 5. PROTOUCH™ GRIPS:**
Are moulded for comfort and provide less hand fatigue



What is TÜV & GS?

- Guaranteed Safety to DIN Standards
- Proven Quality & Reliability

What is VDE?

- Safely working with live electrical equipment up to AC 1000Volt or DC1500Volt

VDE COMBINATION PLIERS

Multi-grip jaw is great for pulling, twisting and cutting wire.

Item No.	Description	EAN	Master Pack	Shelf Pack
10505872	VDE Combination Pliers 6"/150mm	5706915058727	25	5
10505873	VDE Combination Pliers 7"/175mm	5706915058734	25	5
10505874	VDE Combination Pliers 8"/200mm	5706915058741	25	5



VDE LONG AND BENT NOSE PLIERS

Thin nose profile gets into tight spaces, easy to reach around obstructions.

Item No.	Description	EAN	Master Pack	Shelf Pack
10505868	VDE Long Nose Pliers 6"/150mm	5706915058680	25	5
10505869	VDE Long Nose Pliers 8"/200mm	5706915058697	25	5
10505870	VDE Bent Nose Pliers 8"/200mm	5706915058703	25	5

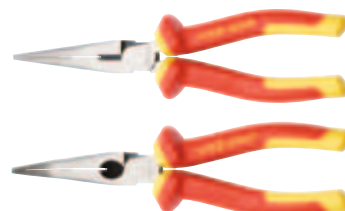

VDE DIAGONAL CUTTING PLIERS

Hardened cutting edges allow for easy cutting of soft and medium wire.

Item No.	Description	EAN	Master Pack	Shelf Pack
10505865	VDE Diagonal Cutting Pliers 6"/150mm	5706915058659	25	5
10505866	VDE Diagonal Cutting Pliers 7"/175mm	5706915058666	25	5
10505867	VDE Diagonal Cutting Pliers 8"/200mm	5706915058673	25	5



VDE WIRE STRIPPER

V-shape Cutters, easy and precise wire stripping up to Ø 1,6 mm cables. Induction hardened cutting edge stays sharp longer.

Item No.	Description	EAN	Master Pack	Shelf Pack
10505871	VDE Wire Strippers 6"/150mm	5706915058710	25	5

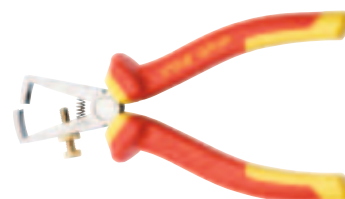

VDE PLIERS SET

Item No.	Description	EAN	Master Pack	Shelf Pack
10505519	3pcs Set (6"/150mm diagonal cutter, 8"/200mm long nose plier, 7"/175mm combination plier)	5706915055191	5	5



IRWIN®

Record.



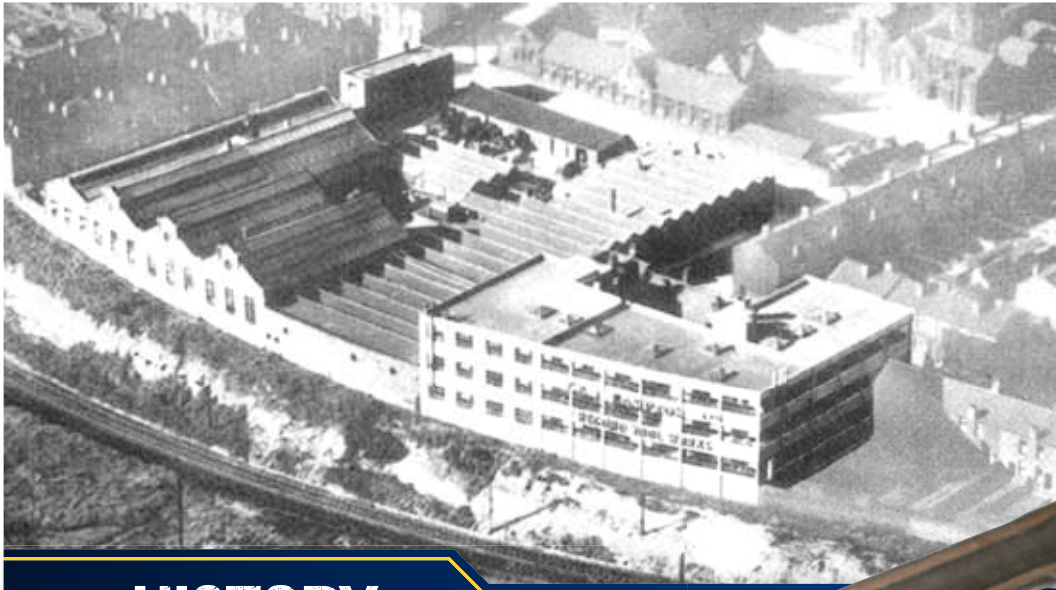

HISTORY



Tools Manufactured for Strength and Longevity

Originally established in 1898 in the South Yorkshire city of Sheffield in the UK.

The Record Tools Factory was swiftly able to make a long lasting contribution to the worldwide reputation of the region for the manufacture of high quality steel and castings.

The Record® brand name was introduced in 1909 and by the 1920's the product range had expanded into Vices, Planes, Clamps and Pipe Wrenches enabling the business to grow rapidly in the UK and many overseas markets.

Today, IRWIN® Record® continues excelling by sticking to the traditional values set by its founders, producing tools that are highly valued amongst professional users for quality and durability that remains strong today.

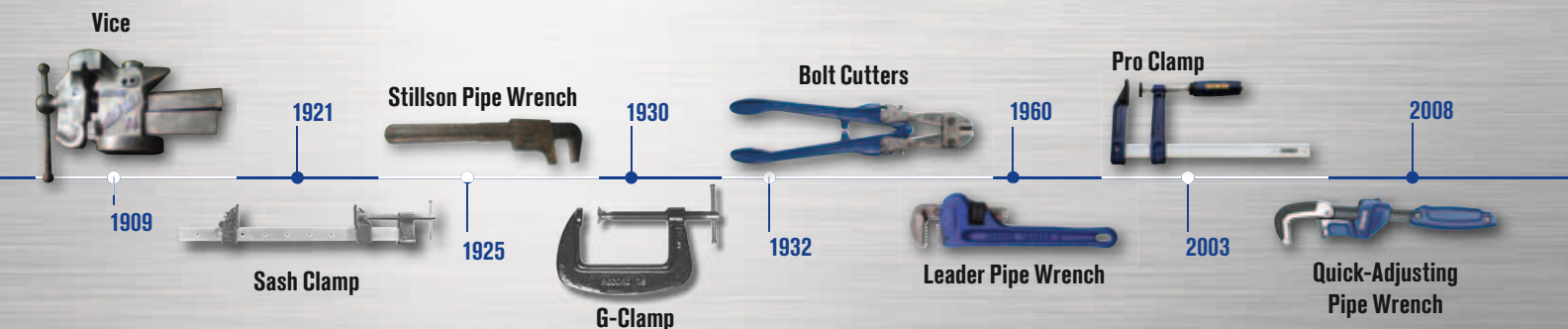

PIPE WRENCHES

IRWIN® Record® offer a full range of plumbing tools designed to get the job done quickly and efficiently. From our solid-forged Stillson Wrenches to the lightweight Quick-Wrench, our range of pipe tools offer superior grip due to the unique 'V-shaped' tooth profile.

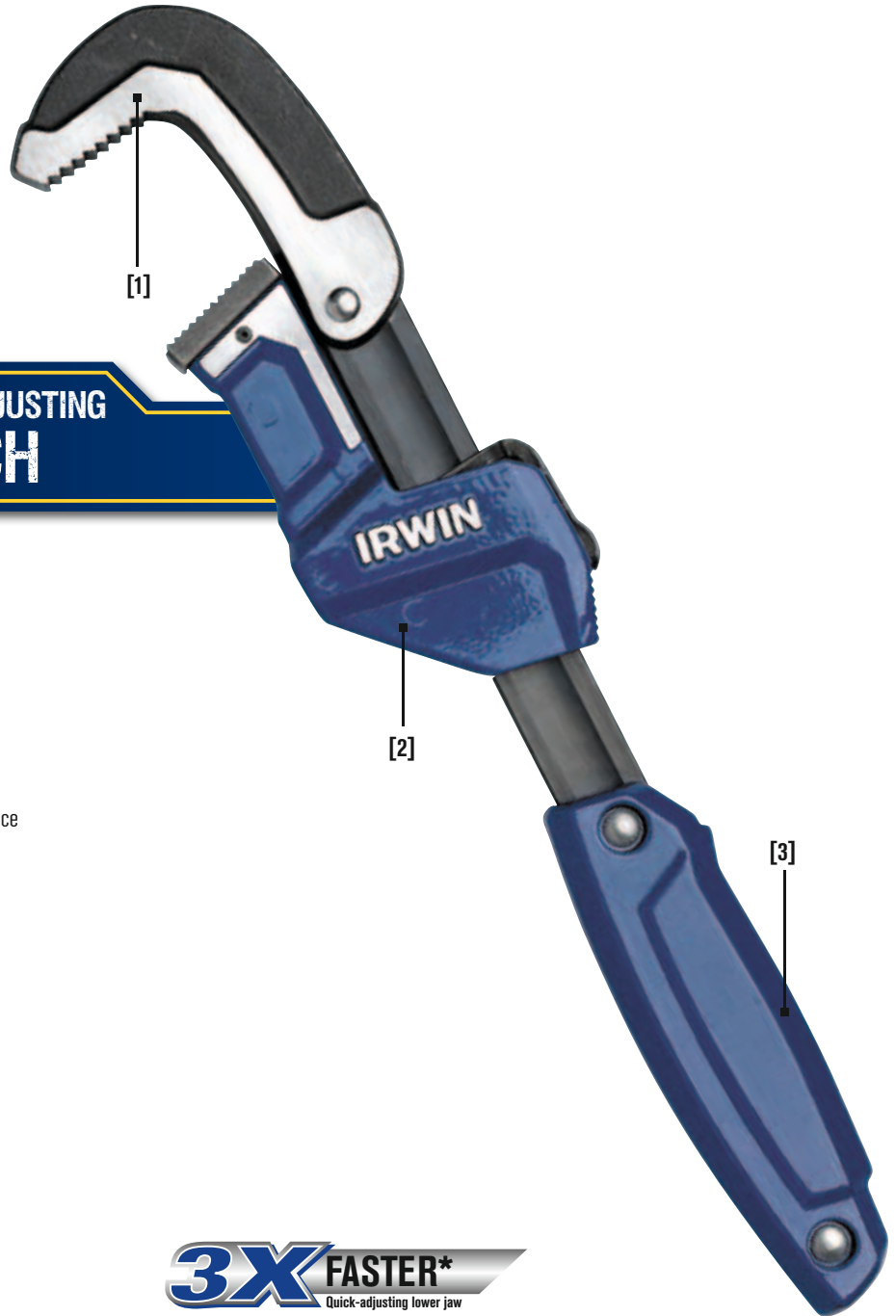

IRWIN® RECORD® QUICK-ADJUSTING PIPE WRENCH

1. FORGED HOOK JAW

With 2-1/4" jaw capacity equivalent to standard 14" pipe wrench; ideal for pipe diameters up to 1-1/2"; ideal for most surfaces including black, galvanized, PVC and copper pipe, as well as nuts, bolts and couplings; broached teeth

2. QUICK ADJUSTING JAW

With one-handed operation, ratchets quickly to work the surface

3. CAST ALUMINIUM CONSTRUCTION

For 40% less weight than standard 14" cast iron pipe wrench; ergonomic handles are ideal for heavy torque and maximum comfort

3X FASTER*
Quick-adjusting lower jaw



* Than traditional pipe wrenches

QUICK-ADJUSTING WRENCH

Item No.	Description	Capacity	EAN	Master Pack	Shelf Pack
10503642	Quick-Adjusting Wrench	3 - 58mm	5706915036428	-	5
10504281	Quick-Adjusting Wrench in Display of 5	3 - 58mm	5706915036428	-	5**

STILLSON PIPE WRENCHES

Item No.	Description	Capacity	EAN	Master Pack	Shelf Pack
T3008	Stillson Wrench 8"/200mm	3/4" (19mm)	0734442111222	-	6
T30010	Stillson Wrench 10"/250mm	1" (25mm)	0734442111368	-	6
T30012	Stillson Wrench 12"/300mm	1-1/4" (32mm)	0734442111603	-	6
T30014	Stillson Wrench 14"/350mm	1-1/2" (38mm)	0734442111849	-	6
T30018	Stillson Wrench 18"/450mm	2" (51mm)	0734442111962	-	4
T30024	Stillson Wrench 24"/600mm	2-1/2" (63mm)	0734442112082	-	1
T30036	Stillson Wrench 36"/900mm	3-1/2" (89mm)	0734442112204	-	1



LEADER PIPE WRENCHES

Item No.	Description	Capacity	EAN	Master Pack	Shelf Pack
T3508	Leader Wrench 8"/200mm	1" (25mm)	0734442112440	-	4
T35010	Leader Wrench 10"/250mm	1-1/2" (38mm)	0734442112563	-	4
T35012	Leader Wrench 12"/300mm	2" (51mm)	0734442112327	-	4
T35014	Leader Wrench 14"/350mm	2" (51mm)	0734442112686	-	4
T35018	Leader Wrench 18"/450mm	2-1/2" (63mm)	0734442112808	-	4
T35024	Leader Wrench 24"/600mm	3" (76mm)	0734442112921	-	1
T35036	Leader Wrench 36"/900mm	5" (127mm)	0734442113041	-	1
T35048	Leader Wrench 48"/1220mm	6" (152mm)	0734442113065	-	1



HANDIWRENCH

Chain pipe wrenches are mainly used in confined spaces, such as against a wall or close to a nest of other piping. Simply loop the chain around the pipe, lock it and the jaws will grip in the direction of the turn. The pipe can then be easily tightened or loosened with short strokes of the handle.

Item No.	Description	Capacity	EAN	Master Pack	Shelf Pack
T240	Handiwrench Ø100	4" (101mm)	0734442113522	48	4



CHAIN PIPE WRENCHES

Item No.	Description	Capacity	EAN	Master Pack	Shelf Pack
T23112	Chain Pipe Wrench Ø61/14"	5/16" - 2", (8-51mm)	0734442109082	12	1
T23212	Chain Pipe Wrench Ø90/21-1/2"	5/16" - 3", (8-76mm)	0734442109204	12	1
T233C	Chain Pipe Wrench Ø115/36"	1/2" - 4", (13-101mm)	0734442113164	6	1
T234C	Chain Pipe Wrench Ø220/51",	1" - 8", (25-203mm)	0734442113287	6	1
T235C	Chain Pipe Wrench 64-1/2"	2" - 12" (50 - 300mm)	0734442114000	6	1





'T' HANDLE HEX KEYS

Manufactured from high-strength and durable chrome vanadium steel. Ergonomic design to ease gripping and handling, improving the torque performance. Routed tip finish for better gripping and holding of screws. Special surface treatment to prevent oxidation and corrosion.

Chrome Vanadium Steel CrV3
High-resistant heat treatment
Oxided
Slot machined
TPR handle high-resistant



ProTouch
GRIPS™

'T' HANDLE HEX KEYS - MM



Item No.	Size	L1	L2	Pcs Per Pack	EAN	Master Pack	Shelf Pack
T10907	2.0 mm	150 mm	98 mm	1	7897095029435	6	1
T10908	2.5 mm	150 mm	98 mm	1	7897095029442	6	1
T10909	3.0 mm	150 mm	98 mm	1	7897095029459	6	1
T10910	4.0 mm	150 mm	98 mm	1	7897095029466	6	1
T10911	5.0 mm	150 mm	98 mm	1	7897095029473	6	1
T10912	6.0 mm	150 mm	112 mm	1	7897095029480	6	1
T10913	8.0 mm	150 mm	112 mm	1	7897095029497	6	1
T10914	10.0 mm	150 mm	112 mm	1	7897095029503	6	1

'T' HANDLE HEX KEYS - IMPERIAL



Item No.	Size	L1	L2	Pcs Per Pack	EAN	Master Pack	Shelf Pack
T10897	3/32"	150 mm	98 mm	1	7897095029336	6	1
T10898	7/64"	150 mm	98 mm	1	7897095029343	6	1
T10899	1/8"	150 mm	98 mm	1	7897095029350	6	1
T10900	9/64"	150 mm	98 mm	1	7897095029367	6	1
T10901	5/32"	150 mm	98 mm	1	7897095029374	6	1
T10902	3/16"	150 mm	98 mm	1	7897095029381	6	1
T10903	7/32"	150 mm	98 mm	1	7897095029398	6	1
T10904	1/4"	150 mm	112 mm	1	7897095029404	6	1
T10905	5/16"	150 mm	112 mm	1	7897095029411	6	1
T10906	3/8"	150 mm	112 mm	1	7897095029428	6	1

'T' HANDLE HEX KEY SETS



Item No.	Description	EAN	Master Pack	Shelf Pack
T10771	8pc Set MM: 2.0, 2.5, 3.0, 4.0, 5.0, 6.0, 8.0, 10.0 mm	7897095029299	3	3
T10770	8pc Set IMPERIAL: 3/32", 1/8", 9/64", 5/32", 3/16", 1/4", 5/16", 3/8"	7897095029282	3	3



SHORT AND LONG ARM HEX KEYS

Manufactured from high-strength and durable chrome vanadium steel. IRWIN® Hex and Torx Keys have a black oxide surface and are specially ground for a better grip. Sizes are permanently stamped on the body for easy and quick identification.

PERMANENT MARKING
Easy identification on the key body



OXIDE FINISHING
High-resistant heat treatment

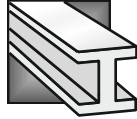

CHROME VANADIUM STEEL 31CrV3
Long lasting

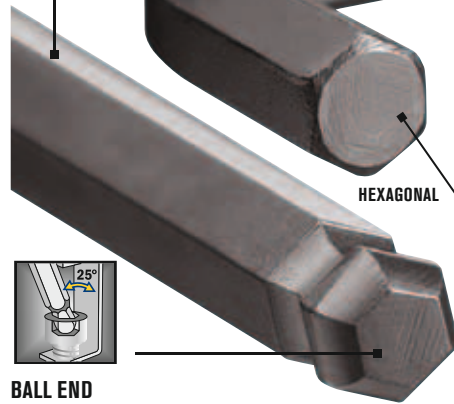

BALL END



QUICK PLUG

HEXAGONAL

TORX®

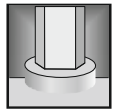

SLOT MACHINED
High precision

SHORT ARM 'L' HEX KEYS - MM

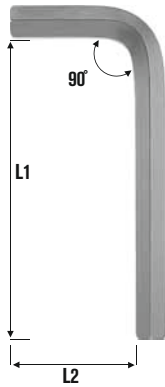

Item No.	Size	L1	L2	Pcs Per Pack	EAN	Master Pack	Shelf Pack
T10567	1.5 mm	45 mm	14 mm	10	7897095027752	10	1
T10568	2.0 mm	50 mm	16 mm	10	7897095027769	10	1
T10569	2.5 mm	56 mm	18 mm	10	7897095027776	10	1
T10570	3.0 mm	63 mm	20 mm	10	7897095027783	10	1
T10571	4.0 mm	70 mm	25 mm	10	7897095027790	10	1
T10572	5.0 mm	80 mm	28 mm	10	7897095027806	10	1
T10573	6.0 mm	90 mm	32 mm	10	7897095027813	5	1
T10574	7.0 mm	95 mm	34 mm	5	7897095027820	5	1
T10575	8.0 mm	100 mm	36 mm	5	7897095027837	5	1
T10577	10.0 mm	112 mm	40 mm	5	7897095027851	5	1
T10578	12.0 mm	125 mm	50 mm	1	7897095027868	10	1
T10579	14.0 mm	140 mm	70 mm	1	7897095027875	-	1
T10580	17.0 mm	160 mm	80 mm	1	7897095027882	-	1

SHORT ARM 'L' HEX KEYS - IMPERIAL



Item No.	Size	L1	L2	Pcs Per Pack	EAN	Master Pack	Shelf Pack
T10548	1/16"	47 mm	17 mm	10	7897095027561	10	1
T10549	5/64"	50 mm	18 mm	10	7897095027578	10	1
T10550	3/32"	53 mm	19 mm	10	7897095027585	10	1
T10551	7/64"	56 mm	20 mm	10	7897095027592	10	1
T10552	1/8"	60 mm	21 mm	10	7897095027608	10	1
T10553	9/64"	63 mm	23 mm	10	7897095027615	10	1
T10554	5/32"	66 mm	24 mm	10	7897095027622	10	1
T10555	3/16"	72 mm	26 mm	10	7897095027639	10	1
T10556	7/32"	79 mm	29 mm	10	7897095027646	5	1
T10557	1/4"	85 mm	31 mm	10	7897095027653	5	1
T10558	5/16"	98 mm	34 mm	5	7897095027660	5	1
T10559	3/8"	110 mm	37 mm	5	7897095027677	5	1
T10560	7/16"	123 mm	41 mm	1	7897095027684	10	1
T10561	1/2"	136 mm	44 mm	1	7897095027691	10	1

LONG ARM 'L' HEX KEYS - MM



Item No.	Size	L1	L2	Pcs Per Pack	EAN	Master Pack	Shelf Pack
T10601	1.5 mm	90 mm	14 mm	5	7897095028094	20	1
T10602	2.0 mm	100 mm	16 mm	5	7897095028100	20	1
T10603	2.5 mm	110 mm	18 mm	5	7897095028117	20	1
T10604	3.0 mm	126 mm	20 mm	5	7897095028124	20	1
T10605	4.0 mm	140 mm	25 mm	5	7897095028131	10	1
T10606	5.0 mm	160 mm	28 mm	5	7897095028148	-	1
T10607	6.0 mm	180 mm	32 mm	5	7897095028155	-	1
T10608	7.0 mm	190 mm	34 mm	5	7897095028162	-	1
T10609	8.0 mm	200 mm	36 mm	5	7897095028179	-	1
T10611	10.0 mm	210 mm	40 mm	1	7897095028193	-	1
T10612	12.0 mm	224 mm	45 mm	1	7897095028209	-	1
T10613	14.0 mm	250 mm	56 mm	1	7897095028216	-	1



LONG ARM 'L' HEX KEYS - IMPERIAL



Item No.	Size	L1	L2	Pcs Per Pack	EAN	Master Pack	Shelf Pack
T10582	1/16"	79 mm	17 mm	5	7897095027905	20	1
T10583	5/64"	83 mm	18 mm	5	7897095027912	20	1
T10584	3/32"	88 mm	19 mm	5	7897095027929	10	1
T10585	7/64"	93 mm	20 mm	5	7897095027936	10	1
T10586	1/8"	98 mm	21 mm	5	7897095027943	10	1
T10587	9/64"	102 mm	23 mm	5	7897095027950	10	1
T10588	5/32"	107 mm	24 mm	5	7897095027967	10	1
T10589	3/16"	117 mm	26 mm	5	7897095027974	10	1
T10590	7/32"	126 mm	29 mm	5	7897095027981	10	1
T10591	1/4"	136 mm	31 mm	5	7897095027998	5	1
T10592	5/16"	155 mm	34 mm	1	7897095028001	-	1
T10593	3/8"	174 mm	37 mm	1	7897095028018	-	1
T10594	7/16"	193 mm	41 mm	1	7897095028025	-	1
T10595	1/2"	212 mm	44 mm	1	7897095028032	-	1

HEX KEY SETS SHORT & LONG



Item No.	Description	EAN	Master Pack	Shelf Pack
T10760	22pc Short and Long MM: 1.5 to 10.0 mm	7897095029183	-	6
T10761	25pc Set IMPERIAL: 1/16" to 3/8"	7897095029190	-	6



BALL END 'L' HEX KEYS - MM



Item No.	Size	L1	L2	Pcs Per Pack	EAN	Master Pack	Shelf Pack
T10626	1.5 mm	76 mm	14 mm	5	7897095028346	20	1
T10627	2.0 mm	81 mm	16 mm	5	7897095028353	20	1
T10628	2.5 mm	89 mm	18 mm	5	7897095028360	10	1
T10629	3.0 mm	100 mm	20 mm	5	7897095028377	10	1
T10630	4.0 mm	112 mm	25 mm	5	7897095028384	-	1
T10631	5.0 mm	121 mm	28 mm	5	7897095028391	-	1
T10632	6.0 mm	140 mm	32 mm	5	7897095028407	-	1
T10633	8.0 mm	163 mm	36 mm	1	7897095028414	-	1
T10634	10.0 mm	190 mm	40 mm	1	7897095028421	-	1
T10635	12.0 mm	223 mm	45 mm	1	7897095028438	-	1

BALL END 'L' HEX KEYS - IMPERIAL



Item No.	Size	L1	L2	Pcs Per Pack	EAN	Master Pack	Shelf Pack
T10614	1/16"	76 mm	15 mm	5	7897095028223	20	1
T10615	5/64"	81 mm	16 mm	5	7897095028230	20	1
T10616	3/32"	86 mm	17 mm	5	7897095028247	20	1
T10617	7/64"	92 mm	17 mm	5	7897095028254	20	1
T10618	1/8"	97 mm	20 mm	5	7897095028261	10	1
T10619	9/64"	102 mm	20 mm	5	7897095028278	10	1
T10620	5/32"	109 mm	22 mm	5	7897095028285	10	1
T10621	3/16"	116 mm	24 mm	5	7897095028292	10	1
T10622	7/32"	125 mm	26 mm	5	7897095028308	5	1
T10623	1/4"	135 mm	29 mm	5	7897095028315	5	1
T10624	5/16"	154 mm	32 mm	1	7897095028322	10	1
T10625	3/8"	174 mm	36 mm	1	7897095028339	-	1

SHORT ARM 'L' TORX KEYS



Item No.	Size	L1	L2	Pcs Per Pack	EAN	Master Pack	Shelf Pack
T10636	T6	42 mm	16 mm	5	7897095028445	20	1
T10637	T7	47 mm	16 mm	5	7897095028452	20	1
T10638	T8	47 mm	16 mm	5	7897095028469	20	1
T10639	T9	47 mm	16 mm	5	7897095028476	20	1
T10640	T10	50 mm	17 mm	5	7897095028483	20	1
T10641	T15	54 mm	18 mm	5	7897095028490	20	1
T10642	T20	57 mm	19 mm	5	7897095028506	20	1
T10643	T25	60 mm	20 mm	5	7897095028513	20	1
T10644	T27	63 mm	22 mm	5	7897095028520	10	1
T10645	T30	70 mm	24 mm	5	7897095028537	10	1
T10646	T40	76 mm	26 mm	5	7897095028544	10	1
T10647	T45	82 mm	28 mm	5	7897095028551	10	1
T10648	T50	95 mm	32 mm	1	7897095028568	10	1
T10649	T55	108 mm	35 mm	1	7897095028575	10	1
T10650	T60	120 mm	38 mm	1	7897095028582	10	1

HOLSTER HEX KEYS SET

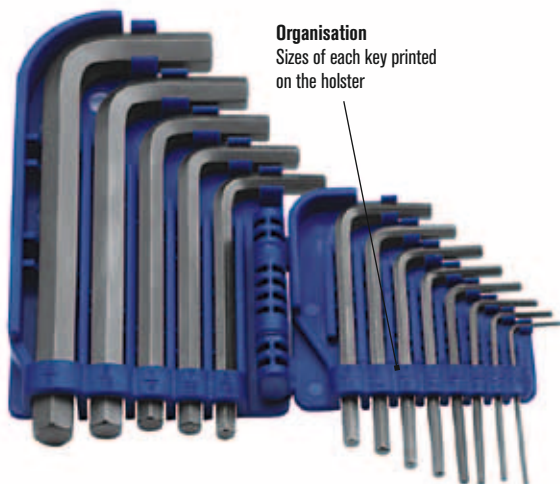

Organisation
Sizes of each key printed on the holster

Holster closes and locks shut for storage



Item No.	Description	EAN	Master Pack	Shelf Pack
T10755	Short Hex Key - MM: 1.5, 2.0, 2.5, 3.0, 4.0, 5.0, 6.0, 7.0, 8.0, 10.0mm	7897095029138	-	6
T10756	Long Hex Key - MM: 1.5, 2.0, 2.5, 3.0, 4.0, 5.0, 6.0, 7.0, 8.0, 10.0mm	7897095029145	-	6
T10757	Ball-Ended Hex Key - MM: 1.5, 2.0, 2.5, 3.0, 4.0, 5.0, 6.0, 7.0, 8.0, 10.0 mm	7897095029152	-	6
T10758	Torx Key: T6, T7, T8, T10, T15, T20, T25, T27, T30, T40	7897095029169	-	6
T10752	Short Hex Key - IMPERIAL: 13pc. 0.050" - 3/8"	7897095029107	-	6
T10753	Long Hex Key - IMPERIAL: 13pc. 0.050" - 3/8"	7897095029114	-	6
T10754	Ball-Ended Hex Key - IMPERIAL: 13pc. 0.050" - 3/8"	7897095029121	-	6

HEX AND TORX KEYS - FOLD UP SETS



Retractable set of IRWIN® Hex and Torx keys housed in a high-resistance, polyamide and fiberglass handle. Ergonomic rubber grip for great comfort and ease of use. Keys are manufactured from black oxide chrome vanadium steel. Includes Hex, Ball-ended or Torx keys.

Item No.	Description	EAN	Master Pack	Shelf Pack
T10765	Hex Key - MM: 2.0, 2.5, 3.0, 4.0, 5.0, 6.0, 8.0 mm	7897095029237	-	6
T10767	Torx Key: T9, T10, T15, T20, T25, T27, T30, T40	7897095029251	-	6
T10769	Ball - Ended Hex Key - MM: 2.0, 2.5, 3.0, 4.0, 5.0, 6.0, 8.0 mm	7897095029275	-	6
T10763	Hex Key - IMPERIAL: 9pc. 5/64" - 1/4"	7897095029213	-	6
T10768	Ball - Ended Hex Key - IMPERIAL: 9pc. 5/64" - 1/4"	7897095029268	-	6



STANDARD HEX KEY SETS



Item No.	Description	EAN	Master Pack	Shelf Pack
T10748	Short Hex Key - MM: 1.5, 2.0, 2.5, 3.0, 4.0, 5.0, 6.0, 8.0, 10.0 mm	7897095029060	-	5
T10749	Long Hex Key - MM: 1.5, 2.0, 2.5, 3.0, 4.0, 5.0, 6.0, 8.0, 10.0 mm	7897095029077	-	5
T10750	Ball-Ended Hex Key - MM: 1.5, 2.0, 2.5, 3.0, 4.0, 5.0, 6.0, 8.0, 10.0mm	7897095029084	-	5
T10745	Short Hex Key - IMPERIAL: 9pc. 1/16" - 3/8"	7897095029039	-	5
T10746	Long Hex Key - IMPERIAL: 9pc. 1/16" - 3/8"	7897095029046	-	5
T10747	Ball-Ended Hex Key - IMPERIAL: 9pc. 1/16" - 3/8"	7897095029053	-	5



Europe, Middle East and Africa (EMEA) Headquarters

Newell Rubbermaid Europe Sarl
Chemin de Blandonnet 10
CH-1214 Vernier / Geneva
Switzerland
Tel: +41 (0) 22 419 00 00
Fax: +41 (0)22 419 01 92

Belgium, Netherlands & Luxemburg

Newell Rubbermaid by
IRWIN Industrial Tools
Edisonstraat 8
5051 DS Goirle - The Netherlands
Tel: +48 (0)61 28 14 200
Fax: +32 (0)20 70 06 026

Eastern Europe

Newell Rubbermaid Poland
Manieczki, ul. Wybickiego 2
63-112 Brodnica - Poland
Tel: +48 (0)61 28 14 200
Fax: +48 (0)61 28 20 524

France

Newell Rubbermaid-
IRWIN Industrial Tools
122, avenue du Général Leclerc
92100 Boulogne Billancourt Cedex - France
Tel: +33 (0) 1 57 32 35 72
Fax: +33 (0) 2 40 38 79 99

Germany, Switzerland and Austria

Newell Rubbermaid -
IRWIN Industrial Tools GmbH
Erching 10 (Schloßgut)
85399 Hallbergmoos - Germany
Tel: +49 (0)69 38 07 89 435
Fax: +49 (0)69 38 07 89 542

Italy

Newell Rubbermaid-
IRWIN Industrial Tools
Viale Edoardo Jenner 55
20159 Milano - Italy
Tel: +39 (0)02 - 66 80 67 61
Fax: +39 (0)02 - 66 80 03 83

Middle East & Africa

A Newell Rubbermaid Company
Dubai Airport Free Zone
West Wing, Building 6W
Block B, Office 640, PO Box - 54554
Dubai - United Arab Emirates
Tel: +971-4-2923444
Fax: +971-4-2923437

Northern Europe

Newell Rubbermaid A/S
Stamholmen 157, 3 sal
2650 Hvidovre - Denmark
Tel: +45 43 68 22 12
Fax: +45 43 68 22 13

Finland

Puh: +358 972 51 92 52
Faksi: +358 972 51 92 53

Sweden

Tel: +46 (0) 8-517 61 670
Fax: +46 (0) 8-517 61 671

Norway

Tel: +47 24 15 99 24
Fax: +47 24 15 99 25

Spain

NEWELL Iberia
Parque Empresarial Las Mercedes
C/ Campezo Nº 1, Edificio 4
3ª planta derecha.
28022 Madrid - Spain
Tel: +34 91 354 48 00

UK

Newell Rubbermaid -
IRWIN Industrial Tools
Halifax Avenue, Fradley Park
Lichfield, Staffordshire WS13 8SS - UK
Main Tel: +44 (0) 1543 44 70 01
Customer Service Tel: 0844 412 1190
Customer Service Fax: 0844 412 1184